

C400 C400WS

C500 C500WS

Undercounter Warewasher

User Manual



UK

Dear Customer,

Thank you for choosing **Classeq**, the warewasher you have selected has been designed to give you lasting service.

Please read these instructions before installing, commissioning, and operating this warewasher.

Make sure all users understand the controls prior to using your warewasher.

Please keep these instructions in a safe place for future reference.

If you have any questions or are not sure about any information contained in this manual please contact either your distributor or **Classeq**. Contact details can be found low down on one side of your warewasher (see back page).

Please record the Model number and Serial number of your warewasher. You will need these if you need to contact **Classeq** for support or to make a claim under the warranty. You will find these on the warewasher rating plate which can be found low down on one side of your warewasher.

Model number:

Serial number:

C400 C400WS

C500 C500WS

Under Counter Range Warewasher

User Manual

CAUTION: Read these instructions before operating the warewasher

Original instructions

TABLE OF CONTENTS

1.	SAFETY	5			
1.1	Symbols Used in this Manual	5	7.4	Regular Maintenance	23
1.2	Danger Warnings	5	7.5	Descaling	23
1.3	Warnings	5	8.	CUSTOM SETTINGS	24
1.4	Cautions	6	9.	TROUBLESHOOTING	28
2.	KNOW YOUR WAREWASHER	7	10.	DECOMMISSIONING	31
2.1	Warewasher Layout	7	10.1	Flush Out Chemical Dosing Systems	31
2.2	Intended Use	8	10.2	Drain the Warewasher	31
2.3	Designation of the Warewasher	8	10.3	Disconnect the Warewasher	31
2.4	Warewasher Controls	8	10.4	Drain the Rinse Tank / Boiler	31
3.	UNPACKING THE WAREWASHER	9	11.	WAREWASHER SPECIFICATIONS	32
3.1	Accessories Supplied	9	11.1	Dimensions	32
4.	INSTALLATION	10	11.2	Technical Data	32
4.1	Recommended Hand Tools	10	11.3	National Approvals Requirements	33
4.2	Warewasher Placement	10	12.	ORDERING ACCESSORIES AND SUPPLIES	34
4.3	Site Requirements	10	13.	PARTS AND LABOUR WARRANTY	35
4.4	Electrical Connection	11			
4.5	Water Supply and Connection	12			
4.6	Wastewater and Connection	14			
4.7	Attaching Chemical Bottles	14			
4.8	Integral Water Softener (if fitted)	15			
5.	COMMISSIONING	16			
5.1	Commissioning Interface	16			
5.2	Commissioning Check Up	16			
5.3	Commissioning Setup	16			
6.	OPERATION	18			
6.1	Operation Interface	18			
6.2	Turning on the Warewasher	18			
6.3	Warewasher Ready to Operate	18			
6.4	Wash and Rinse Temperatures	19			
6.5	Selecting a Wash Program	19			
6.6	Loading a Dishwasher Basket	19			
6.7	Loading a Glasswasher Basket	20			
6.8	Starting a Cycle	20			
6.9	Draining Down the Warewasher	20			
6.10	Warewasher Malfunction	21			
7.	MAINTENANCE AND SERVICING	22			
7.1	Prior to Cleaning	22			
7.2	Daily Cleaning	22			
7.3	Limescale Build Up	22			

1. Safety

1.1 Symbols Used in this Manual.

The following symbols are used in this Manual:



DANGER!

Warning against potential serious or fatal injuries to persons if the described precautionary measures are not taken.



Warning!

Warning against potential minor injuries to persons or potential material damage if the described precautionary measures are not taken.



Caution

Warning against defects in or destruction of the product if the described precautionary measures are not taken.



Recycling instructions.



This symbol refers to a chapter with more detailed information



For safety reasons the warewasher **MUST** be bonded to adjacent metalwork or earthed so that it is at the same potential (i.e. voltage).



For safety reasons, two persons are required for the task.

1.2 Danger Warnings



For safety reasons your warewasher **MUST** be bonded to adjacent metalwork or earthed so that it is the same potential (i.e., voltage) (►4.4).



A means for disconnection that has all poles separation of more than 3mm must be incorporated in the fixed wiring in accordance with wiring rules (►4.3).



If a mains supply cable is damaged, it must be replaced by a cable supplied by Classeq, its service agents or similar qualified persons, to avoid hazards.



All mains electrical work must be carried out in accordance with local and national regulations, and by a qualified electrician (►4.4.1).



Ensure the base of the warewasher is never submerged or standing in water when operating the warewasher (►7).

1.3 Warnings



The warewasher should only be operated at or within the voltage specified on the rating plate (►2.3).



If Classeq warewashers are used outside the designation for the appliance, you invalidate your warranty and make the appliance unsafe.



Maximum inlet water pressure is 1 MPA and minimum inlet water pressure is 200 kPA.



Use only the hose supplied with your warewasher to connect it to the water supply. Old existing, defective, or damaged water supply hoses **MUST NOT** be used (►4.5.3).



The installer and user are responsible for ensuring the installation and operation of this warewasher are in accordance with this Manual and local and national regulations (►4).



DO NOT use electrical extension lead(s) to supply power to your warewasher (►4.4.1).



Children should be supervised to ensure that they do not play with or operate the warewasher (►6).



Be aware that wares may be hot when removed from the warewasher (►6.8).



Before cleaning the Wash Chamber, ensure all sharp items, such as broken glass or other items which could cause injury, are removed carefully.



DO NOT use cleaning agents that contain CHLORINE, BLEACH or HYPOCHLORITE.



Wear the correct Personal Protective Equipment, e.g., gloves and goggles, when handling chemicals and observe all safety notes and dosing recommendations printed on the packaging. (►4.7) (►7.5) (►10.1).

















If the warewasher is being drained immediately after use, water draining from the 'Boiler drainage hose' may be hotter than **95°C** (►10.4).



For models fitted with an internal drain pump, the wastewater outlet **MUST** not exceed the maximum drain height.

1.4 Cautions

-  Damage to the warewasher caused by lime scale or poor water quality will **NOT** be covered by the **Manufacturer's Warranty** (▶7.3).
-  In hard water areas (>3°dH), **DO NOT** run the warewasher without the use of either an internal or external water softener as this could result in damage to the warewasher. Failure to observe this warning will invalidate the warranty.
Warewashers with WS in the model type are fitted with an internal water softener.
-  **DO NOT** run the warewasher without salt in the Salt Reservoir as this will allow limescale to build up. Limescale deposits in the warewasher will invalidate the warranty (▶4.5.2).
-  **Only use granulated salt** (*max. grain size 7 mm*). Salt tablets are not suitable (▶7.4.1).
-  **DO NOT** add any chemicals, such as detergent or rinse aid to the Salt Reservoir. These will cause damage to the warewasher (▶7.4.1).
-  Only use commercial grade detergents and rinse aids in your warewasher (▶4.7).
-  If the Salt Reservoir Cap is not properly secured, water and/or chemicals can leak in or out of the unit causing damage to the warewasher (▶7.4.1).
-  Always remove excess food / debris from any dishes / glasses to be washed. **DO NOT** use your warewasher as a waste disposal unit (▶6.8).
-  It is very important that the warewasher is drained down at the end of each working day (▶6.9).
-  **DO NOT** use STEEL WOOL, WIRE BRUSHES or any other abrasive materials.
-  De-scale chemical must not remain in the warewasher for more than 2 hours (▶7.5).
-  Items placed on the open door of the warewasher must not exceed 20kg (▶7).
-  **DO NOT** spray the exterior or interior of the warewasher and the surrounding area (*panels, base*) using a water jet, steam cleaner or high-pressure cleaner.
-  The function of this warewasher is the washing of dishes, plates, glassware, cutlery, and similar articles only. No other activity is permitted with this warewasher.
-  Authorised spare parts only must be used in the event of a breakdown.

2. Know Your Warewasher

Before installing your warewasher you should familiarise yourself with the various components shown below.

2.1 Warewasher Layout

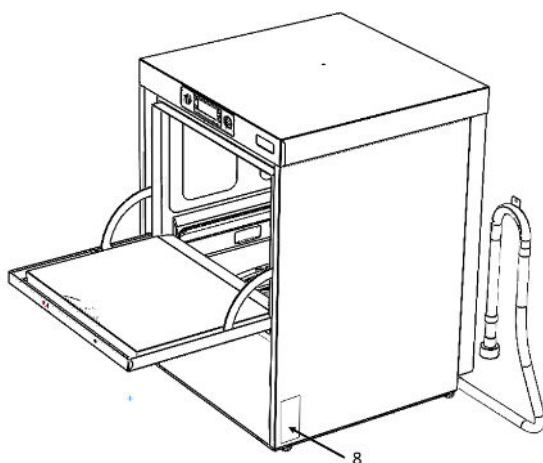
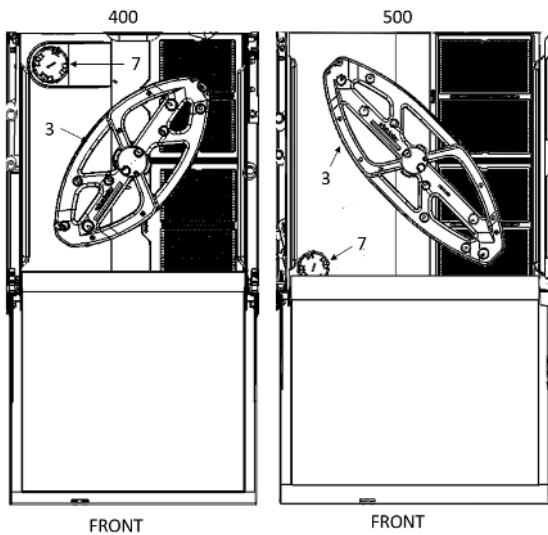
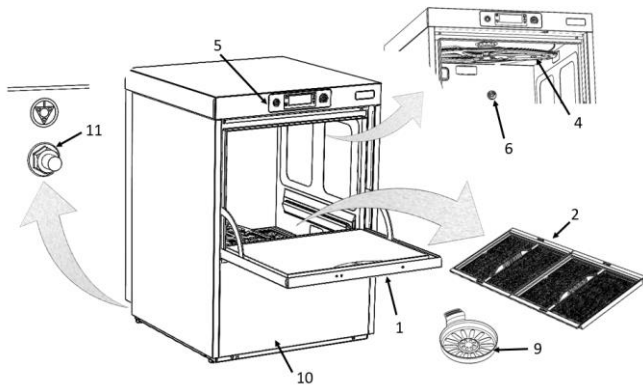

Item	Description
1	Door (Note 1)
2	Primary Filters
3	Bottom Wash and Rinse Arms
4	Top Wash and Rinse Arms
5	Control Panel
6	Anti-syphon device
7	Salt Reservoir Cap (Note 2)
8	Rating Plate
9	Secondary Filters
10	Removable Lower Front Panel
11	Earth bonding stud

Notes:

1. The Door of the warewasher should never be used as a step or seat.
2. Fitted to warewashers with a Water Softener only.
3. Water softener is located at the rear on C400 unit.
4. Water softener is located at the front on C500 unit.

2.2 Intended Use

2.2.1 Glasswasher

The intended use is the washing of glasses.

2.2.2 Dishwasher

The intended use is the washing of kitchen and tableware.

2.3 Designation of the Warewasher

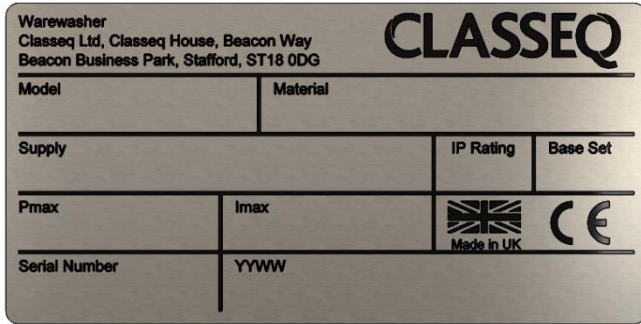

Example:

Model	C500
Material	854V7772
Supply	230V N 50Hz
IP Rating	4
Base Set	31
Pmax	6.58kW
Imax	30A per phase
Serial Number	400xxxxxx
YYWW	2335

2.4 Warewasher Controls

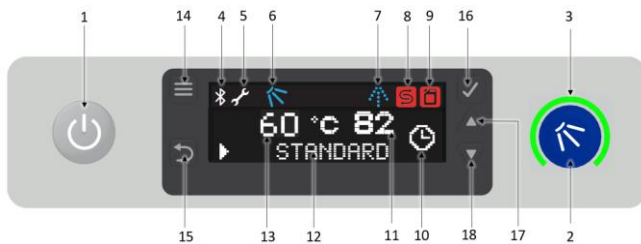

Item	Description
1	On/Off button
2	Cycle button
3	LED indicator (Note 1)
4	Bluetooth Access
5	Service mode Indicator
6	Wash Indicator
7	Rinse indicator
8	Refill Salt indicator (Note 2)

9	Low Chemical Indicator (Note 3)
10	Program selected
11	Rinse water temperature
12	Stage Information
13	Wash water temperature
14	Menu Button
15	Back Button
16	Select Button
17/18	UP Button & Down Button

Notes:

1. LED indicator:



FLASHING AMBER - warewasher not ready (Wash Tank not full / Rinse Tank not full / Wash Tank still heating / Rinse Tank still heating).



GREEN - warewasher is ready / in standby (Wash Tank full / Rinse Tank full).

Note that Tank full interlocks always apply. Operating temperature interlocks can be altered as required (C5.2.3).



BLUE - Warewasher is in Wash cycle.

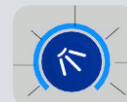

FLASHING BLUE - In Drain Cycle.



RED - In Service Mode.



RED - If not in Service mode, then it indicates Error warning.

Contact: CLASSEQ's Service or Technical support.

- Only on warewashers with fitted Water Softeners.
- Function available to warewashers fitted with external chemical lancer only.

3. Unpacking the Warewasher

After unpacking your warewasher, check it for any transport damage. Never install and use a damaged warewasher. If your warewasher is damaged contact your retailer immediately.

Make sure the water and electricity connections of your warewasher comply with the specifications given in this Manual.

Remove all outer packaging and the protective film from your warewasher before positioning it.

Remove any accessories shipped inside the warewasher and unpack them carefully.

Ensure all packaging materials are disposed of in accordance with local and national regulations.

3.1 Accessories Supplied

The warewasher is supplied with the following accessories (**Note 1**):

	Open Basket x2 Glasswasher x1 Dishwasher		Plate Basket x1 Dishwasher only
	Cutlery Basket x1 Dishwasher only		Primary Filters x2
	Secondary Filter x1		Water Inlet Hose x1
	Bottle Weights x2		Waste Hose Hook x1
	Good Practice Guide		Quick User Guide x1
	Installation kit x1		2kg Bag of Salt x1 (Note 3)
	Water Softener Funnel x1 (Note 3)		

Notes:

1. Images are for reference only, actual parts supplied may differ.
2. Differs depending on drain type.
3. Fitted to warewashers with a Water Softener only.

4. Installation



Warning!

The installer and user are responsible for ensuring the installation and operation of this warewasher are in accordance with this manual and with local and national regulations.

4.1 Recommended Hand Tools

The following hand tools are required when installing the warewasher:

- Spirit level
- 8mm spanner
- Multimeter or voltmeter
- Insulated No. 2 Posi screwdriver
- Drill with 8mm bit

4.2 Warewasher Placement

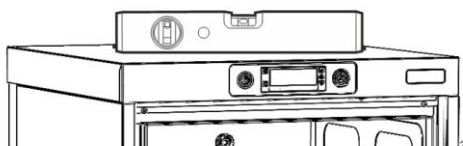

Your warewasher should be installed on a flat, stable surface that can hold the full weight of the filled warewasher and withstanding the vibration of regular use

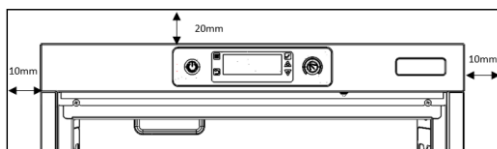

Ensure there is a minimum of 10mm clearance on each side of your warewasher and 20 mm clearance at the top of the warewasher (► 4.3).

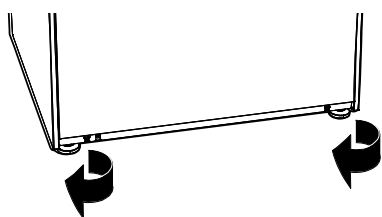

Once your warewasher is in its final position, adjust the adjustable feet to ensure the warewasher is stable, its weight is being distributed equally, and it does not tilt more than 2 degrees in any direction.

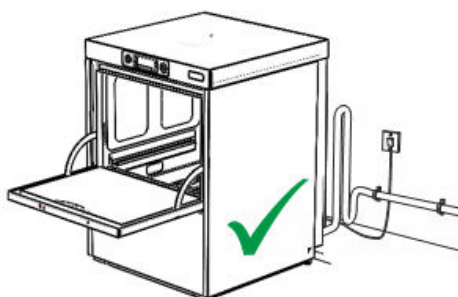

Your warewasher should be placed in a location that allows the electrical, supply water and waste water connections to be fitted (► 4.3).



When positioning your warewasher, ensure that the water inlet, chemical tubes and drain hoses are not kinked or squashed. Care must also be taken to ensure the warewasher does not rest on any of its supply hoses / leads.

4.3 Site Requirements

Overall Warewasher and Clearance Dimensions

Dimensions (mm)		C400	C500
Ware-washer	A = width	460	600
	B = depth	570	600
	C = height (min)	720	820
Recess	D = width	480	620
	E = depth (min)	570	600
	F = height	770	870

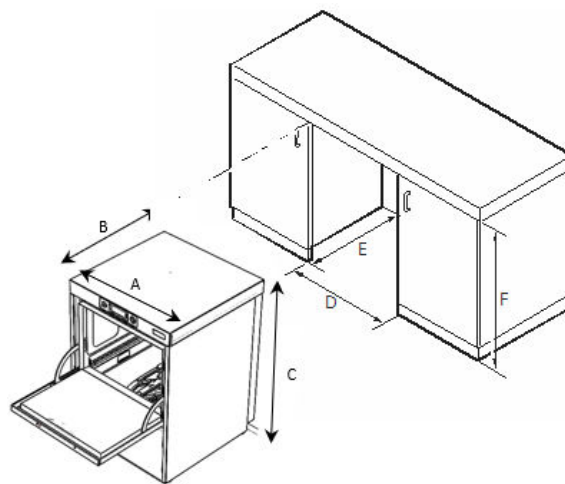

Weights (kg)	C400	C400 WS	C500	C500 WS
Empty		32	40.3	
Fully Loaded		43.5	46.8	

Electrical Supply

Electrical connections MUST be carried out in accordance with local regulations. As a minimum **Classeq** recommends the following are maintained:

- All warewashers are connected via a residual current device (RCD) or earth leakage protection device.
- A means for disconnection that has all poles separation of more than 3 mm must be incorporated in the fixed wiring in accordance with wiring rules.
- Connect to an equipotential conductor, connection stud located at rear of the warewasher, this is in addition to the earthed electrical supply.
- Prior to connecting the warewasher, ensure voltage and supply fuse comply with rating plate.

Electrics		C400 / C400WS	C500 / C500WS
Supply 1	220-240V (1-phase) 13A	2.5 kW	2.5kW
Supply 2	380-415V (3-phase) 13A	6.5 kW	6.5 kW
Supply 3	220-240V (1-phase) 30A	6.5 kW	6.5 kW
Supply 4	220-240V (1-phase) 20A	4.5kW	4.5 kW

Supply Socket (mm)		D400 / G400	D500 / G500
Max position of electrical supply socket (mm)	W = width	950	700
	H = height (max)	1500	1550

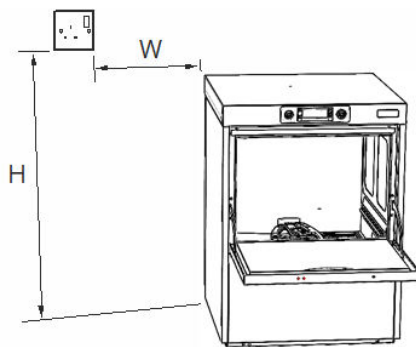

Water Inlet

		D400 / G400	D500 / G500
Temperature range		4 - 55°C	
Pressure	0 - 2 bar	Rinse booster pump required	
	2 - 10 bar	No modification	
Flowrate		4 l/min	

		D400 / G400	D500 / G500
Water connection		G ^{3/4} " (3/4" BSP)	
Maximum position of water supply (mm)	W = width	650	600
	H = height	700	650

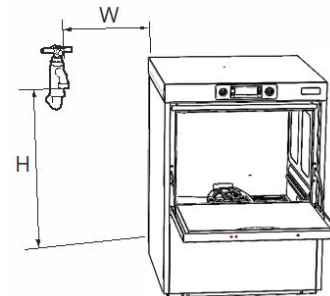

Waste Outlet

Drainage Dimensions (mm)	D400 / G400	D500 / G500
Drain standpipe diameter	35	35
W = maximum distance from warewasher	750	400
Drain pipe height (drain pump)	0 - 500	0 - 600

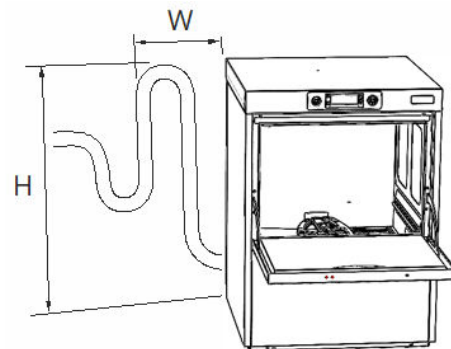

4.4 Electrical Connection

4.4.1 Mains cable connection

Prior to connecting the warewasher, ensure that the available electrical outlet voltage and the supply fuse comply with the rating of the warewasher. For the electrical rating of your warewasher refer to the rating plate.

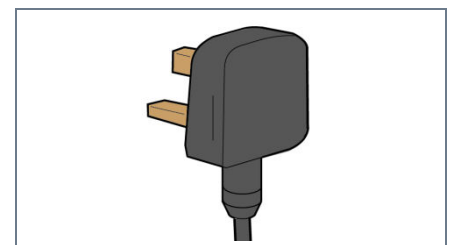

Contact your distributor, a qualified electrician, or **Classeq** if you are unsure how to check this.

The electrical supply must incorporate a disconnection device (circuit breaker / fuse) that complies with local and national regulations.

Your warewasher must be connected directly to the mains electricity using the mains electrical cable provided. DO NOT use electrical extension lead(s) to supply power to your warewasher.



DANGER!
All mains electrical work **must** be carried out in accordance with local and national regulations by a qualified electrician.

4.4.2 Electrical connection specification

Depending on the specification of your warewasher it may be supplied with or without a moulded mains electrical plug. When hard wiring the warewasher into the mains outlet, use a multimeter or voltmeter to ensure that the connection point is electrically isolated before attempting to make the connections.

4.4.3 Electrical cable specification

If the mains electrical supply cable is damaged or has deteriorated, it MUST be replaced by a cable or cord assembly supplied by **Classeq**, its service agents or suitably qualified persons to avoid hazards and be to the following minimum specifications.

Warewasher rating (Volts / Phase / Amps)	Cable size	Temperature rating	Length of cable	Conforms to
220-240V / 1N~/30A	3G / 4.0			
380-415V / 3N~/12A	5G / 2.5			
380-415V / 3N~/16A	5G / 2.5	60°C min.	3m	H07RN-f
380-415V / 3N~/22A	5G / 4.0			

For electrical rating of your warewasher refer to the rating label (►2.3).

4.4.4 Equipotential bonding



DANGER!
For safety reasons your warewasher MUST be bonded to adjacent metalwork or earthed so that it is at the same potential (*i.e. voltage*).

Consult your distributor, **Classeq** or a qualified electrician if you are unsure how to do this.

The equipotential bonding stud is located at the rear of the warewasher and is fitted with an M5 nut. Use the 8mm spanner to connect the bonding wire terminal to this location and ensure the nut is securely fastened.

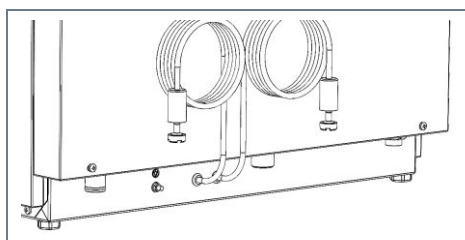

4.5 Water Supply and Connection

4.5.1 Water supply restrictions

Commercial warewasher wash results may be affected by external conditions such as incoming water temperature, pressure, hardness, and choice of chemicals.

Supply water temperature:

- 4°C minimum
- 55°C maximum

Supply water dynamic pressure:

The dynamic pressure of the water supply will determine whether your warewasher needs additional equipment to be installed in the water supply system, as follows:

Measured water pressure	Consequence
0 to 2 bar (0 to 200 kPa)	An external rinse booster pump must be installed
2 to 10 bar (200 to 1000 kPa)	No modifications required - warewasher can be installed with a direct hose connection to the existing water supply.

Minimum supply flow rate:

- With Water Softener: 4 litre/minute.

Water hardness:



Caution
Damage to the warewasher caused by limescale will **NOT** be covered by the manufacturer's warranty (►0).

For the longevity of your warewasher, and to ensure you get consistently good washing results, your warewasher must wash with soft water, i.e., water that contains a low concentration of ions, in particular ions of calcium and magnesium. There are three ways to achieve this:

- The supply water must be naturally soft.
- Your warewasher is specified to be fitted with an internal Water Softener (models **C400WS** and **C500WS**).
- Your water supply to the warewasher is from a suitable external water softener unit.

4.5.2 Water hardness explained

Water hardness occurs because certain chemicals in the rocks through which the water passes on its way to the consumer slowly leach out into the water.

The problem shows itself in two forms:

1. When hard water is heated the chemicals come out of the solution and appear as solid particles (limescale) that are carried round the warewasher. These particles are formed most quickly at the hottest part of the warewasher - typically, the rinse element and the Rinse Tank. Therefore, the Rinse Tank is the best place to look to judge if limescale is being formed in a warewasher.
2. Most commercial washing chemicals operate much less efficiently in hard water, and this will often show as poor

results, failure to remove tannin stains or condensation on glasses. Tannin stains appear to cling to the hard water film in the drink, which then clings to the surface of the cup or saucer. With soft water this is not the case.

Some types of hard water do not produce limescale when heated, but still reduce the performance of washing chemicals, as mentioned above. This is known as permanent hardness. Temporary hardness is when the hardness can be largely removed by conversion into limescale by boiling.

If limescale is produced inside a warewasher it will cause several maintenance problems, for example:

- Coating of heating elements leading to slow heating and eventually, element failure.
- Blockage of rinse jets, showing as poor results.
- Wear of bushes in the centre boss, showing as poor results and possibly wash water passing backwards into the rinse system.
- Blockage of the rinse aid injection point in the boiler.
- White marks appearing on glasses, dishes, and cutlery.
- Dishes or cups may appear dirty even after a wash. Especially coffee or teacups.
- Discolouration of the inside of the warewasher, making cleaning difficult.
- Blockage of hoses due to limescale deposits "furring up" the inside of the hoses.



When limescale is found, it must be removed with commercial de-scaling chemicals, used with care in accordance with the instructions on the product.

The descaling instructions in this manual should always be followed.

The Rinse Tank is difficult to de-scale and a service engineer may be required to carry this out.

Your local water board / water supply company should be able to tell you if the water in your area is hard or soft.

Alternatively, you can establish the hardness of your water supply yourself using a simple water hardness testing kit.

Water Softener settings:

Your Water Softener needs to be set up to soften the water supply depending on the water hardness, according to the following table:

Water Softener Setting	Hardness				Water Volume (litres)	No. of cycles
	°dH	°e/°clark	°fh	ppm		
h00	---- Water Softener deactivated ----				-----	-----
h01	1	1.3	1.8	18	48.1	16
h02	2	2.5	3.6	36	45.7	15

Water Softener Setting	Hardness				Water Volume (litres)	No. of cycles
	°dH	°e/°clark	°fh	ppm		
h03	3	3.8	5.4	54	43.4	14
h04	4	5.0	7.2	71	41.2	14
h05	5	6.3	9.0	89	39.0	13
h06	6	7.5	10.7	107	36.9	12
h07	7	8.8	12.5	125	34.9	12
h08	8	10.0	14.3	143	32.9	11
h09	9	11.3	16.1	161	31.0	10
h10	10	12.5	17.9	179	29.2	10
h11	11	13.8	19.7	196	27.4	9
h12	12	15.0	21.5	214	25.7	9
h13	13	16.3	23.3	232	24.1	8
h14	14	17.5	25.1	250	22.5	7
h15	15	18.8	26.9	268	21.0	7
h16	16	20.0	28.6	286	19.5	7
h17	17	21.3	30.4	303	18.2	6
h18	18	22.5	32.2	321	16.9	6
h19	19	23.8	34.0	339	15.9	5
h20	20	25.0	35.8	357	14.4	5
h21	21	26.3	37.6	375	13.3	4
h22	22	27.5	39.4	393	12.3	4
h23	23	28.8	41.2	411	11.3	4
h24	24	30.0	43.0	428	10.4	3
h25	25	31.3	44.8	446	9.6	3
h26	26	32.5	46.5	464	8.8	3
h27	27	33.8	48.3	482	8.1	3
h28	28	35.0	50.1	500	7.4	2
h29	29	36.3	51.9	518	6.8	2
h30	30	37.5	53.7	536	6.3	2

4.5.3 Water supply hose connection

Classeq recommend installing a shut off valve in the mains water supply line near the warewasher such that it is easily accessible.

Your warewasher is supplied with a new UK Water Regulations Advisory Scheme (WRAS) approved water inlet hose, requiring a G $\frac{3}{4}$ " ($\frac{3}{4}$ " BSP) male threaded connection at the mains water outlet.



Warning!

Use only the hose supplied with your warewasher to connect it to the water supply. Old existing, defective, or damaged water supply hoses **MUST NOT** be used.

Connect the 90-degree bend connector of the water supply hose to the inlet on the back of your warewasher and the straight connector to the mains water supply.

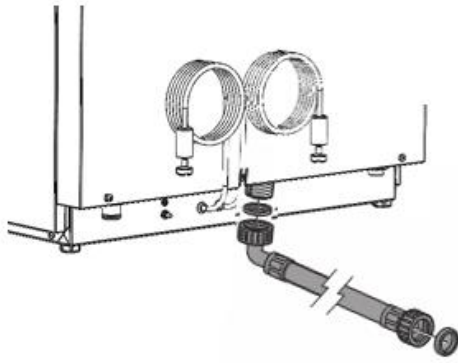

- Ensure the rubber seals are in place in the connectors.
- Hand tightens the connectors only.
- Ensure all connections are watertight before using your warewasher.

4.6 Wastewater and Connection

Pumped drain warewashers:

The outlet end of the waste hose of a pumped drain type warewasher can be trimmed to fit a variety of sizes of pipes / spigots.

The waste plumbing for this type of warewasher can be up to a maximum of the following heights from the base of the warewasher:

Warewasher size	Max waste height (mm)
(C400)	540
(C500)	600

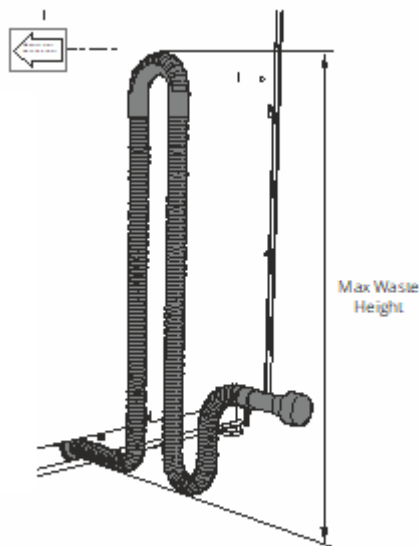

Fit the waste hose of your warewasher to the existing waste piping. Ensure that the waste hose is not kinked. Ensure that the waste hose is fitted in such a way that it will not come off or out of the existing waste piping during warewasher operation.

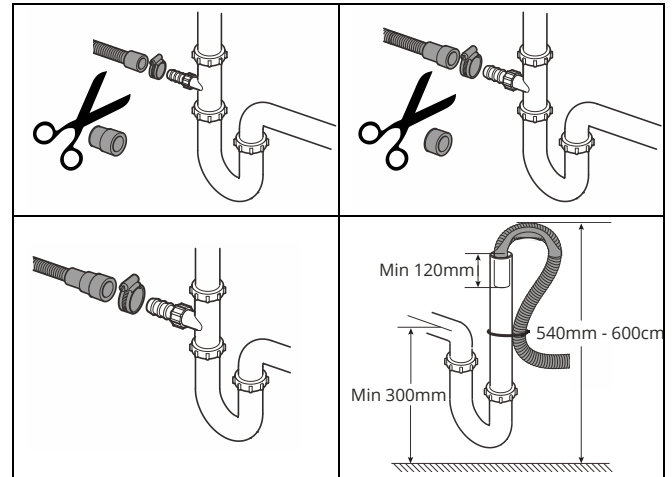

The wastewater from your warewasher must be disposed of down the foul drains system, i.e. the drains from sinks and WCs. The wastewater from your warewasher **must not** be connected to the surface water drainage system.

A form of back flow prevention must be installed into the wastewater plumbing in accordance with local and national regulations.

Ensure that no part of the waste hose from the warewasher is higher than the mark on the rear of the warewasher (shown), when the warewasher is in place.

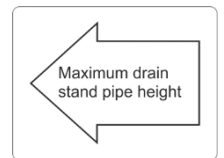

Where the warewasher is fitted to a standpipe, the Waste Hose Hook should be used to help manage the hose.

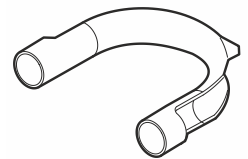

4.7 Attaching Chemical Bottles

Warning!

Wear the correct Personal Protective Equipment, e.g., gloves and goggles, when handling chemicals and observe all safety notes and dosing recommendations printed on the packaging.



Caution

Only use commercial grade detergents and rinse aids within your warewasher.



The chemical bottles should be placed in a safe, stable location that is close to the warewasher and easily accessible to check the levels and replace the bottles as needed.

A coil of PVC tubing is connected to each of the chemical pumps inside the warewasher.

These tubes exit the rear of the warewasher and should be routed to the chemical bottle locations. The tubes need to be long enough to allow the bottles to be moved without the risk of falling over. Excess tubing may be cut off.

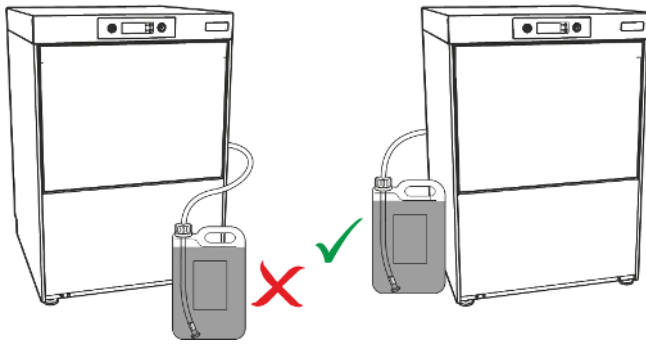

Tubing colour	Chemical
BLUE	Rinse aid
CLEAR	Detergent

4.7.1 Preparing the bottles

1. Remove the cap from the chemical bottle.
2. Using the drill and 8mm bit, carefully drill a hole in the centre of the cap.
3. Feed the tube through the hole.
4. Fit the bottle weight over the tube and then attach the end of the tube to a filter.
5. Feed the filter and bottle weight into the bottle and screw on the cap.

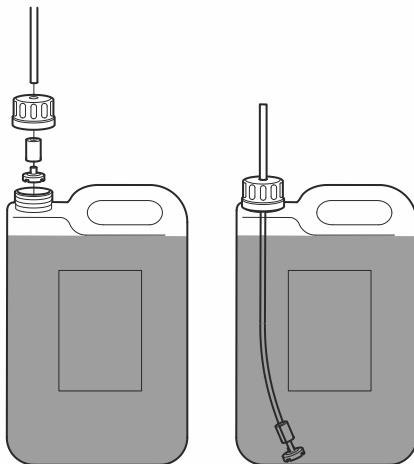

4.8 Integral Water Softener (if fitted)

To commission the Water Softener unit, follow the instructions below:

1. Open the door to the warewasher.
2. Remove the Salt Reservoir Cap:
C400WS- Back left-hand corner of the Wash Chamber.
C500WS - Front left-hand corner of the Wash Chamber.
3. Fill the Reservoir with fresh water.
4. Using the Water Softener Funnel supplied, fill the Reservoir with approximately 1.5kg of granulated salt.
5. Wipe away any excess or spilt salt from the Wash Chamber and the Reservoir opening.
6. Refit the Salt Reservoir Cap, ensuring that the Cap is fitted flat and secure.

7. Do not overtighten the Salt Reservoir Cap.

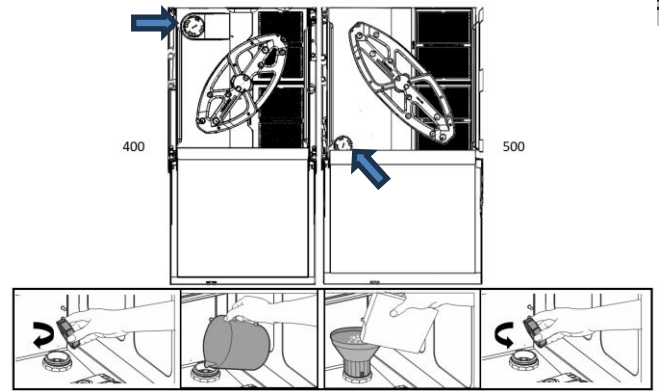

Caution

DO NOT run the warewasher if there is no salt in the salt reservoir, as this will allow limescale to build up. Limescale deposits in the warewasher will invalidate the warranty.



Caution

DO NOT add any chemicals, such as detergent or rinse aid to the reservoir. These will cause damage to the warewasher.



Caution

Only use granulated salt (max. grain size 5 – 7 mm). Salt tablets are not suitable.



Caution

If the Reservoir Cap is not properly secured, water and/or chemicals can leak in or out of the unit causing damage to the warewasher.

5. Commissioning

5.1 Commissioning Interface



Item	Description
1	ON button
2	Menu button
3	Select button
4	Back button
5	Up button
6	Down button
7	Display Screen
8	LED indicator – Service Mode

5.2 Commissioning Check Up

5.2.1 Chemicals

Your warewasher will be set to the default chemical dosing settings. However, since there are many different chemicals on the market and each of these have different concentration requirements, the dosage can be adjusted by following the instructions given below:



Refer to the chemical bottle or contact the chemical supplier to find the concentration requirements for the rinse aid and detergent in millilitres of chemical per litre of water (ml/L).

5.2.2 Water Softener (If fitted)

Check the hardness of your water supply (°d). You can establish the hardness of your water supply yourself using a simple water hardness testing kit or you may be able to get this information from your local Water Supply Company.

Refer to the Water Softener settings table to find the setting required for your water hardness.

For External Water softener unit, refer Supplier specification and water capacity between regeneration.

5.2.3 Wash and Rinse Tank Temperatures

The Wash and Rinse Tank (Boiler) temperatures have been factory set to pre-set temperatures. These temperatures do not normally need to be adjusted by the user.

Please refer to the latest version of the Engineers Manual on the Classeq website for full information regarding temperatures and interlock settings.

5.3 Commissioning Setup

When warewasher is power up first time, it will automatically go into the commissioning mode before you can start using the warewasher. Follow the instruction as displayed on Display screen (7)

STEP 1: Select Language using Up & Down buttons (5 & 6). Confirm the selection by pressing Select button (3).



LANGUAGES OPTIONS



STEP 2: Confirm Initial SETUP by pressing Select Button (3).



STEP 3: Select type of warewasher, Glass or Dish using Up & Down buttons (5 & 6). Confirm the selection by pressing Select button (3).



STEP 4: Set Sound Notification when cycle preference by using Up & Down buttons (5 & 6). Confirm the selection by pressing Select button (3).



STEP 5: This Step is for the warewasher with internal Water Softener Only. Set Water Hardness setting by using Up & Down buttons (5 & 6). Confirm the selection by pressing Select button (3). Default is set at highest level 30°DH.

Minimum: 0°DH and Maximum: 30°DH.

Please note at minimum setting of 0°DH, water softener is deactivated.



STEP 6: This Step is for the warewasher with External Water Softener Only. Set external Water treatment capacity in litres setting by using Up & Down buttons (5 & 6). Confirm the selection by pressing Select button (3). Refer supplier data for the external water softener device.

Minimum is 1 litres and Maximum is 9999 Litres.



STEP 7: Set Detergent dose by using button (5) & (6) as per the concentration required in millilitres per litre of Water (ml/L). Confirm the selection by pressing Select button (3). Default is set at 3.0ml/L.

Minimum: 0.1 ml/L and Maximum: 9.99ml/L



STEP 8: Set Rinse Aid dose by using button (5) & (6) as per the concentration required in millilitres per litre of Water (ml/L). Confirm the selection by pressing Select button (3). Default is set at 0.1ml/L.

Minimum: 0.1 ml/L and Maximum: 9.99ml/L



STEP 9: Start priming by selecting button (3). Make sure tubes are not kinked and free of obstruction. Priming last for 15 minutes but you can stop early by pressing button (4).

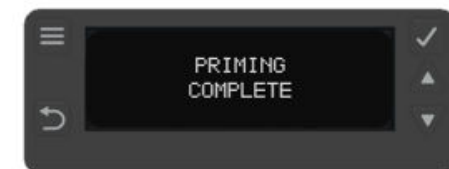
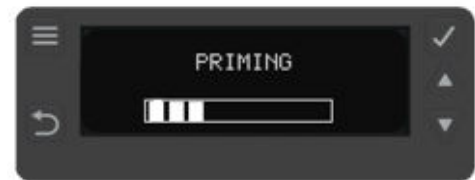
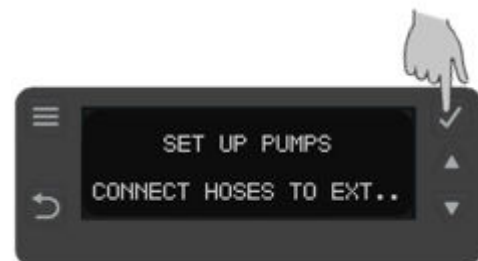
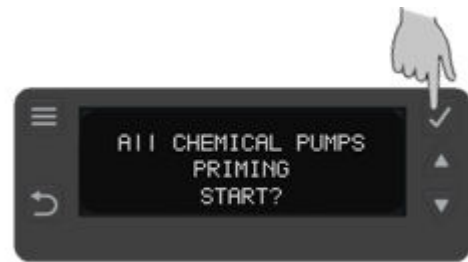

STEP10: This is just a display (7) of commissioning completion. Warewasher is ready now to use.

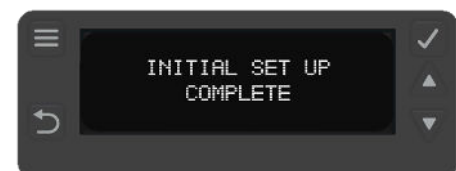

6. Operation

Before operating the warewasher, ensure that the mains electrical and water supplies are turned on.

Children must be supervised to ensure that they do not play with, or operate, the warewasher.

6.1 Operation Interface

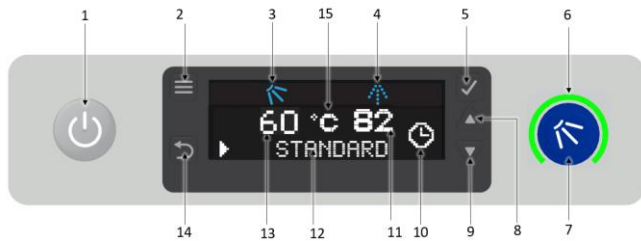

Item	Description
1	On/Off button
2	Menu button
3	Wash CYCLE display
4	Rinse CYCLE display
5	Select button
6	LED indicator
7	Cycle button
8	UP selection button
9	DOWN selection button
10	Program display
11	Rinse Temperature
12	Stage display
13	Wash Temperature
14	Return button
15	Temperature Unit

Notes:

1. LED indicator (6) and Stage Display (12):



FLASHING AMBER LED Indicator (6) - warewasher not ready (Wash Tank not full / Rinse Tank not full / Wash Tank still heating / Rinse Tank still heating).

Stage Display (12) - will show progress of the filling and heating stage.



Note that Tank full interlocks always apply. Operating temperature interlocks can be altered as required (► 5.2.3).



GREEN LED indicator (6) means warewasher is ready to start the cycle.



Stage display (12) to display ready information.



Blue LED indicator (6) means warewasher is in cycle.



Stage display (12) to display wash programme selected information.



RED LED indicator (6) means a serious error condition has occurred.

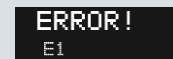

Stage display (12) to inform Error number. Please refer section () for more details.

6.2 Turning on the Warewasher



To turn on the warewasher, ensure the door is closed and press the On/Off button (1) on the Control Panel. The display will illuminate and the warewasher will start to fill if the door is closed.

6.3 Warewasher Ready to Operate



The warewasher operates a pulse fill function, this means that it will fill the Rinse Tank, heat this to a pre-set temperature (60°C) then transfer this water to the Wash Tank. During the fill stage the LED indicator (6) will flash amber.

Once the Wash Tank is filled the LED indicator will illuminate green to indicate the warewasher is ready to run a cycle.



The time required for the warewasher to fill, and heat will vary depending on the power rating of the warewasher, as stated on the rating label (► 2.3), and the incoming water temperature.

Below is a guide to these fill and heating times when the incoming water is 16°C.

Rating	Time
220-240V / 1N~ / 13A	40 min
220-240V / 1N~ / 28A	25 min
380-415V / 3N~ / 11A	25 min

6.4 Wash and Rinse Temperatures

The temperature displays (13 and 11) on the warewasher can be shown in °C or °F (15). Refer CUSTOM SETTING in this Manual below and refer CHANGE UNIT section. (► 8.0).

Nominal Temperatures set in the factory:

	Dishwasher	Glasswasher
Wash	60°C / 140°F	60°C / 140°F
Rinse	82°C / 180°F	70°C / 158°F

6.5 Selecting a Wash Program

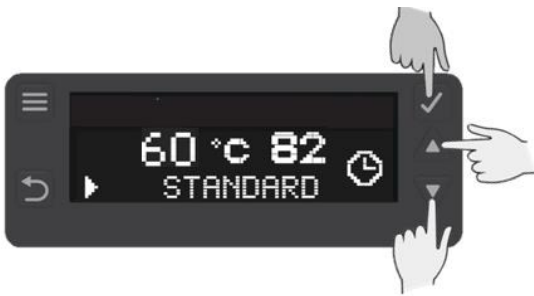

Your warewasher has multiple program times; these are pre-set to offer the best possible results. Selected Program is displayed (12). To change a program, press the UP & DOWN button (8 & 9) and press Select button (5) to confirm.

When the warewasher is turned on (► 6.2) it will always start on the 'STANDARD' program.

6.5.1 Dishwasher program options:

Display	Description	Approximate Time (min)
	Light	2
	Standard	3
	Intensive	5

6.5.2 Glass washer program options:

Display	Description	Approximate Time (min)
	Light	1.5
	Standard	2

Your warewasher has a heat interlock to ensure that the rinse is to temperature. This will extend the wash cycle if the Rinse Boiler has not achieved the required temperature within the cycle times given above.

For full information on operating temperatures and the interlock, please refer to the latest version of the Engineers Manual on the Classeq website for full information regarding temperatures and interlock settings.

6.6 Loading a Dishwasher Basket

For dishwashers ONLY

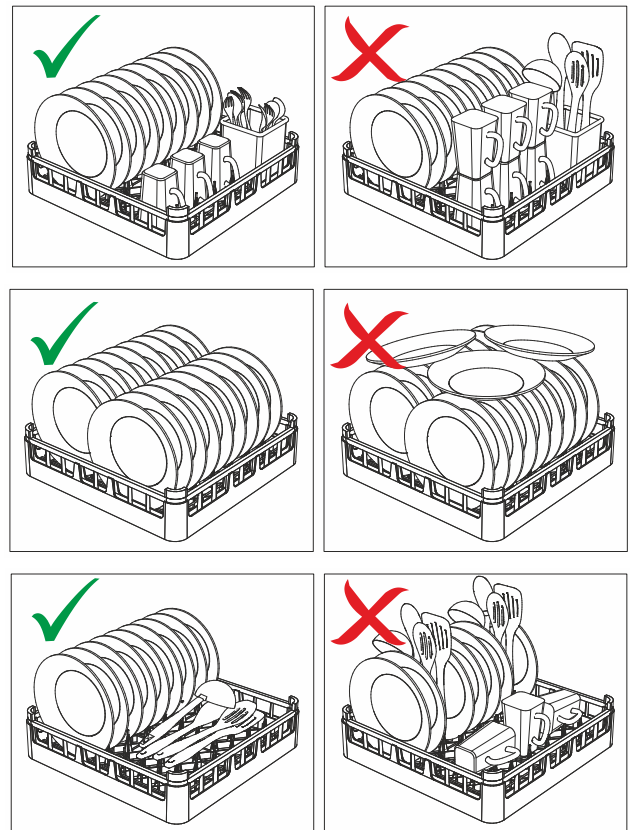

6.6.1 Is it Suitable?

Before loading any item into your dishwasher, check that it is dishwasher compatible.

- Pots and pans made of aluminium or stainless steel are normally safe to put in a dishwasher - but always check for a dishwasher-safe indication on the base of the pans. If this is not obvious, check the manufacturer's website or label.
- Non-stick pans - many manufacturers state that they are dishwasher safe, however, always check for a dishwasher-safe indication on the base of the pans. If

this is not obvious, check the manufacturer's website or label.

- Items made of brass, bronze, wood, or china with gold leaf embellishment are not suitable for washing in a dishwasher. Wash these items by hand.
- Large kitchen knives may suffer over time if washed in a dishwasher. Wash these items by hand.

6.6.2 Preparation

Large chunks of leftover food should be scraped off plates / bowls / pans.

For best results pre-rinse all dirty wares before they go in the dishwasher. Pre-rinse in plain hot water or water with dishwasher detergent added to it. Do not use handwash detergent as this may cause foaming when the wares are transferred into the dishwasher.

6.6.3 Service Cutlery

Knives, forks, and spoons should be loaded into the Cutlery Basket. Load forks and spoons handle end down. Load knives handle end up, to prevent cuts when unloading the warewasher / Basket. Do not overfill the compartments. Do not sort into cutlery types, i.e., do not fill one compartment in the Basket with all spoons as these may nest with each other and not wash properly.

6.6.4 Tableware

Adjust the Plate Basket Inserts to suit your plate / bowl size. Stack plates / bowls so that they are free draining. Large platters should be placed face down in the bottom of a Basket.

6.6.5 Preparation / Serving Utensils

Long utensils / cutlery, such as ladles and long knives etc., must be placed horizontally on the bottom of an Open Basket. This will avoid possible collision with Wash / Rinse Arms.

6.6.6 Pots and Pans

Pots and pans should be placed in an Open Basket face down. Try not to overlap items.

6.7 Loading a Glasswasher Basket

For glasswashers ONLY

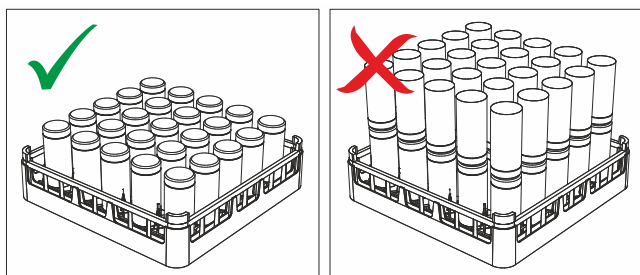

Glasses should be placed in the Open Basket open end down.

Always try to fill the Basket - to prevent glasses from clinking against each other during a wash cycle.

With tall glasses always check carefully that they will fit in the glasswasher when stood upright in the Open Basket.

6.8 Starting a Cycle

Always remove excess food / debris from any dishes / glasses to be washed. **DO NOT** use your warewasher as a waste disposal unit.

To start a cycle, follow the instructions given below.

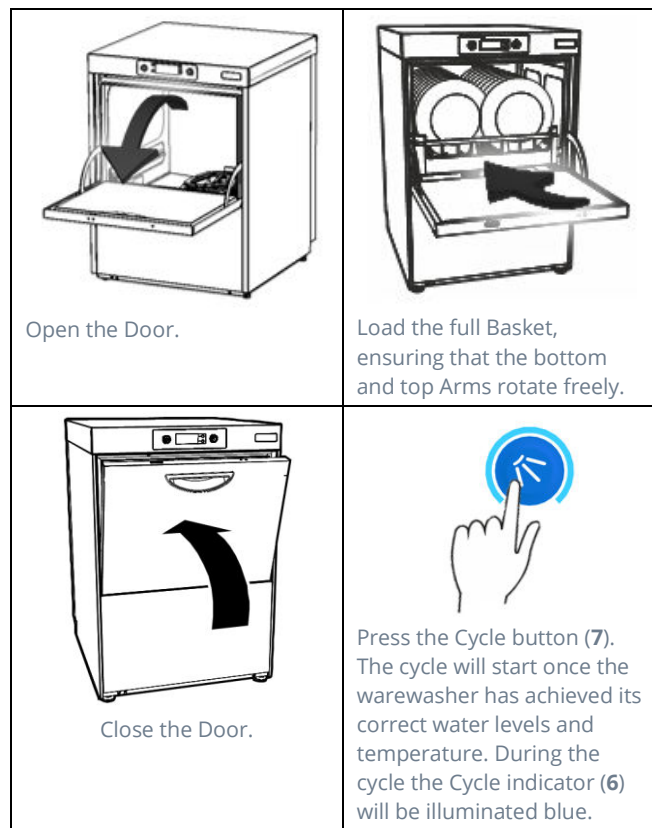

Do NOT open the door during a cycle.



If the Cycle button is pressed before the warewasher has reached the required levels and temperatures the Cycle indicator (6) will flash amber, and the warewasher will automatically start when the requirements have been met.

1. At the end of the cycle, the blue Cycle indicator (6) goes out. Open the Door and remove the Basket.
2. Reload the warewasher and repeat as required.

Wares in the basket may be wet and will dry in a short time due to evaporation.



Warning!

Wares may be hot when removed from the warewasher.

6.9 Draining Down the Warewasher







Caution

It is very important the warewasher is drained down at the end of each working day.

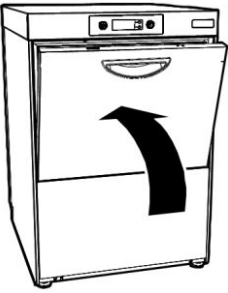
During normal operation the warewasher will drain out any excess water.

To fully drain down the warewasher follow the instructions given below.

 <p>Close the Door to the warewasher.</p>	<p>Press the On/Off button (1) to turn off the warewasher.</p>
 <p>Press the On/Off button (1) to turn off the warewasher.</p> <p>Press the Select button (5) to start the drain cycle.</p> <p>Stage display (12) will show the progress of the drain cycle.</p>	
 <p>The warewasher will drain down the Wash Tank.</p>	
 <p>The warewasher will do a self-rinse and shutdown automatically.</p>	
	



Notes:

1. Once empty, **Classeq** recommends that the mains water and electricity supplies are turned off and the warewasher is cleaned (►7.2).
2. For hygiene reasons it is recommended that once the warewasher has been drained and cleaned the door is left open to assist in natural drying of the Wash Chamber.

6.10 Warewasher Malfunction

In the event of a warewasher malfunction:

- Switch the warewasher off using the On/Off button.
- Isolate the electrical supply to the warewasher.
- Turn off the water supply.
- Request a service callout.

7. Maintenance and Servicing



DANGER!

The warewasher MUST be disconnected from its power source during cleaning, servicing or when replacing parts.



DANGER!

Ensure the base of the warewasher is never submerged or standing in water when operating the warewasher.



Caution

DO NOT spray the exterior or interior of the warewasher and the surrounding area (*panels, base*) using a water hose, steam-jet air ejector or high-pressure cleaner.



Caution

Ensure that the items placed on the open door of the warewasher do not exceed 20kg in weight.

7.1 Prior to Cleaning

Ensure the warewasher has first been drained down (► 6.9).

Turn off the mains electrical supply before cleaning the warewasher.



Warning!

DO NOT use cleaning agents that contain CHLORINE, BLEACH or HYPOCHLORITE.



Warning!

Before cleaning the Wash Chamber, ensure all sharp items, such as broken glass or other items which could cause injury, are removed carefully.



Caution

DO NOT use STEEL WOOL, WIRE BRUSHES or any other abrasive materials.

7.2 Daily Cleaning

It is recommended that the warewasher is cleaned daily to ensure good hygiene in the warewasher.

7.2.1 Interior cleaning

The interior of the warewasher should be cleaned after each service when the warewasher is drained down.

As a minimum **Classeq** recommends the following are checked and cleaned:

- Remove and clean the top and bottom Rinse and Wash Arms.

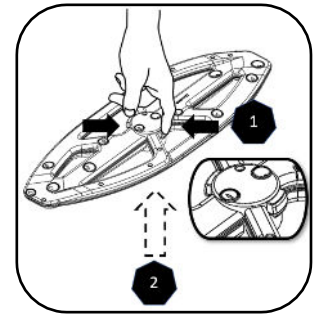

- Remove and clean the primary and secondary filters.

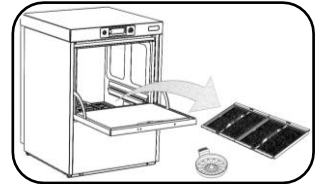

- Clean the interior of the Wash Tank with a sponge and/or brush for all apertures and outlets.
- Clean around the door hinge.

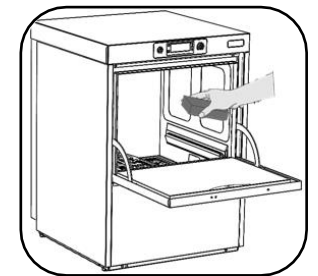

- Use a small bottle brush followed by a trigger spray bottle with a jet nozzle, clean the ball in the anti-syphon device (pumped drain warewashers only).
- If required apply food grade grease to the Door Ball Catch.

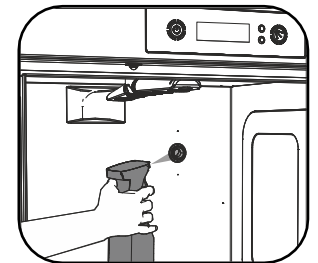

Ensure all arms and filters are refitted to the warewasher before turning the warewasher on.

7.2.2 Exterior cleaning

Wipe the exterior of the warewasher with a damp (*NOT WET*) sponge.

Once dry, clean using a STAINLESS-STEEL cleaning agent.

7.3 Limescale Build Up

For best results ensure your warewasher is operated with soft water so that limescale does not build up.

If your warewasher is connected to an external Water Softener, ensure this is routinely regenerated as per the manufacturer's instruction manual.

If your warewasher has an internal Water Softener fitted ensure the salt level is maintained as per the instructions in this manual.

If your warewasher is operated with hard water, without the relevant water treatment, the internal workings and water lines

can become scaled, your washing results will deteriorate and the warewasher could be damaged. For more information on hard water refer to Water Supply and Connection (►4.5).



Caution

Damage to the warewasher caused by limescale will **NOT** be covered by the manufacturer's warranty (►0).

7.4 Regular Maintenance

7.4.1 Water softener salt (if fitted)

When the salt level inside the Salt Reservoir gets low the Refill Salt indicator will illuminate on the display.

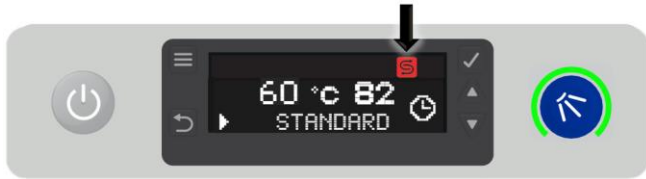

The salt should be replenished as soon as possible to avoid limescale from building up in your warewasher. To refill the Salt Reservoir, follow the instructions below:

1. Open the door to the warewasher.
2. Remove the Salt Reservoir Cap at the back left hand corner of the Wash Chamber on C400WS or left-hand corner on C500WS.
3. Using the Salt Funnel supplied, fill the Reservoir with granulated salt.
4. Wipe away any excess or spilt salt from the Wash Chamber and the Reservoir opening.
5. Refit the Salt Reservoir Cap, ensuring that the Cap is fitted flat and secure.
6. Do not overtighten the salt reservoir cap.
7. Drain down the warewasher and refill to remove any residual salt water after refilling the reservoir.

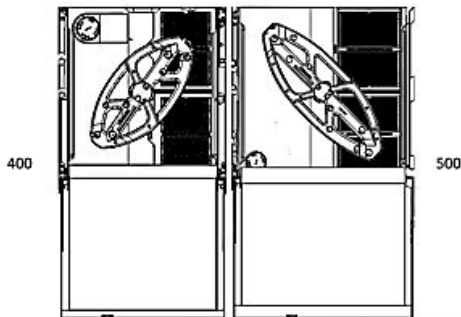

Note: The Refill Salt indicator may stay illuminated for up to three complete wash cycles after filling / refilling the Salt Reservoir with salt.



Caution

DO NOT run the warewasher if there is no salt in the Salt Reservoir, as this will allow

limescale to build up. Limescale deposits in the warewasher will invalidate the warranty.



Caution

DO NOT add any chemicals, such as detergent or rinse aid to the Salt Reservoir. These will cause damage to the warewasher.



Caution

Only use granulated salt (max. grain size 5 – 7 mm). Salt tablets are not suitable.



Caution

If the Salt Reservoir Cap is not properly secured, water and/or chemicals can leak in or out of the unit causing damage to the warewasher.

7.5 Descaling

You can de-scale the Wash Tank of your warewasher yourself with the help of the following notes: to de-scale the Rinse Boiler you will need to contact your service engineer or **Classeq**.



Warning!

Wear the correct Personal Protective Equipment, e.g., gloves and goggles, when handling chemicals and observe all safety notes and dosing recommendations printed on the packaging.



Caution

De-scale chemical must not remain in the warewasher for more than 2 hours.

To descale the Wash Tank, follow the instructions below:

1. Remove the chemical tubes from the chemical bottles and place the ends of the tubes into a container of water.
2. Use the commissioning menu to prime the Rinse Aid and Detergent Pump to draw water all the way into the warewasher.
3. Fill and drain the warewasher to remove any chemical residue.
4. Refill the warewasher.
5. Follow the instructions on the chemical packaging to de-scale the Wash Tank.
6. Once the de-scale process is complete drain the warewasher.
7. Refill and drain the warewasher at least 3 times to remove any chemical residue.
8. Refit the chemical tubes to the bottles and prime the Pumps (►4.7).
9. Do not overtighten the salt reservoir cap.

8. Custom Settings

Your warewasher comes with factory pre-set value and updated value during your commissioning of the machine. In event of any change in circumstances (e.g. language, change of chemical, hardness etc) your warewasher has a provision to updates those values.

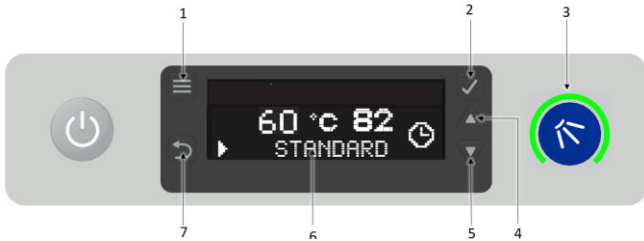

Item	Description
1	Menu button
2	Select button
3	LED indicator
4	Up button
5	Down button
6	Display Screen
7	Back Button

Refer below instructions to customise your settings:

Press Menu Button (1) when warewasher is ON to enter the Setting Mode from Normal Mode. LED indicator (3) light colour changes to RED to notify warewasher is in Setting mode.

By pressing UP Button (4) and DOWN Button (5) parameters under settings can be scroll. To select your specific parameter press Select Button (2) to change the value. Press Back Button (7) to come out of Setting Mode.

Please Note only qualified technician or engineer should get access to **SERVICE** Parameter.

LANGUAGE

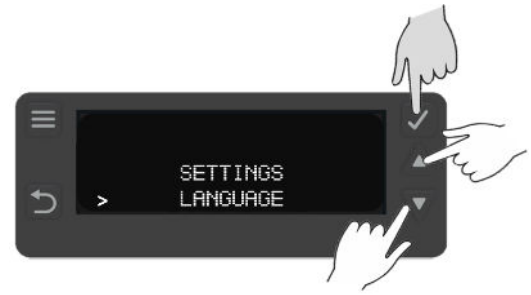

Press Select Button (2) to enter the language options. Press UP Button (4) & DOWN Button (5) to select your choice of Language. Confirm your selection by pressing Select Button (2).

To come out of Setting Mode press Back Button (7).

Available languages are:



CHEMICALS



Press Select Button (2) to enter the chemicals options. Press UP Button (4) & DOWN Button (5) to select your choice of Chemical Pump. Confirm your selection by pressing Select Button (2).

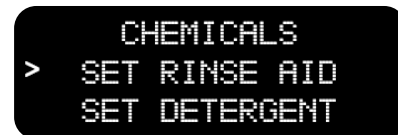

CHEMICALS - RINSE AID



Press Select Button (2) to enter the PUMP operation options. Press UP Button (4) & DOWN Button (5) to select your choice of operation. Confirm your selection by pressing Select Button (2).

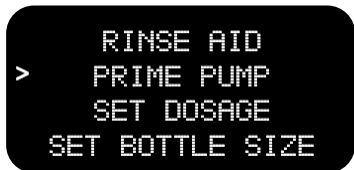

- Selecting PRIME PUMP OPTION will activate the pump for fixed specified time until Back button (7) is pressed, whichever comes first.
- Selecting DOSAGE option allows you to change dosage setting in ml per litres.



Adjust Rinse Aid dose by using button (4) & (5) as per the concentration required in millilitres per litre of Water (ml/L). Confirm the selection by pressing Select button (2). Default is set at 0.1ml/L.

Minimum: 0.1 ml/L and Maximum: 9.99ml/L

Press Back button (7) to return to previous menu.

- Selecting SET BOTTLE SIZE options enable Rinse Aid re-fill reminder based on the Rinse Aid bottle size. Ware washer estimates the usage of chemical based on volume of water machine has used and chemical dosage setting.



By pressing UP Button (4) & DOWN Button (5), you can set the chemical refill reminder notification ON. Press Select Button (2) to confirm the selection. Default is set to OFF.

Minimum: OFF and Maximum: 30L

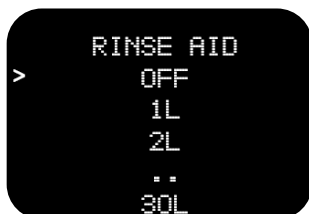

Please Note: In an event of empty chemical bottle, reminder note will notify on display (6) to refill the chemical before the start of cycle.

CHEMICALS – DETERGENT

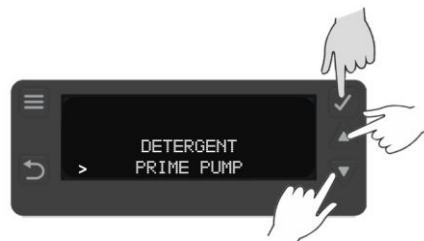

Press Select Button (2) to enter the PUMP operation options. Press UP Button (4) & DOWN Button (5) to select your choice of operation. Confirm your selection by pressing Select Button (2).

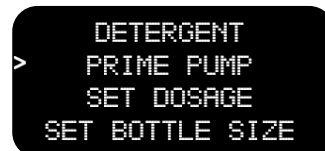

- Selecting PRIME PUMP OPTION will activate the pump for fixed specified time until Back button (7) is pressed, whichever comes first.
- Selecting DOSAGE option allows you to change dosage setting in ml per litres.

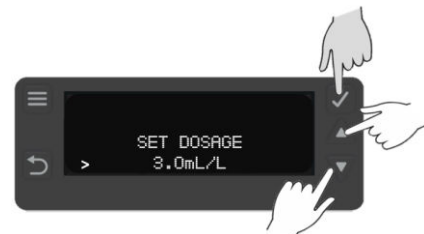

Adjust Detergent dose by using button (4) & (5) as per the concentration required in millilitres per litre of Water (ml/L). Confirm the selection by pressing Select button (2). Default is set at 3.0 ml/L.

Minimum: 0.1 ml/L and Maximum: 9.99ml/L

Press Back button (7) to return to previous menu.

- Selecting SET BOTTLE SIZE options enable detergent re-fill reminder based on the Detergent bottle size. Ware washer estimates the usage of chemical based on volume of water machine has used and chemical dosage setting.

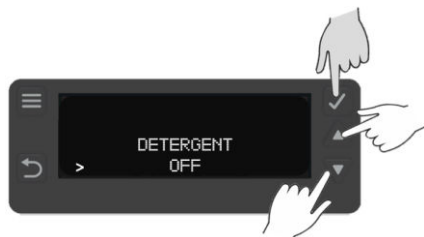

By pressing UP Button (4) & DOWN Button (5), you can set the chemical refill reminder notification ON. Press Select Button (2) to confirm the selection. Default is set to OFF.

Minimum: OFF and Maximum: 30L

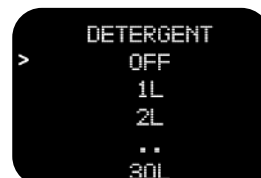

Please Note: In an event of empty chemical bottle, reminder note will notify on display (6) to refill the chemical before the start of cycle.

Press Back button (7) to return to previous menu.

WATER HARDNESS



Press Select Button (2) to enter the Water Hardness settings
Press UP Button (4) & DOWN Button (5) to select water hardness value. Confirm your selection by pressing Select Button (2). Default is set at highest level 30°DH.

Minimum: 0°DH and Maximum: 30°DH.

Please note at minimum setting of 0°DH, water softener is deactivated.



Press Back button (7) to return to previous menu.

ALERT SOUND



Press Select Button (2) to enter the ALERT SOUND option Press UP Button (4) & DOWN Button (5) to select value. Confirm your selection by pressing Select Button (2). Default is set to OFF.



Please Note: This is a visual sound to notify end of the cycle.

Press Back button (7) to return to previous menu.

BLUETOOTH

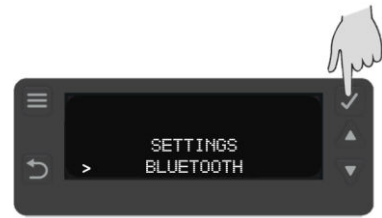

Press Select Button (2) to enter and confirm the BLUETOOTH setting. Default setting is Enable. Bluetooth allows to connect warewasher to Classeq's App, which is available on Play store or Google Play for free. Through APP, you connect your warewashers to view overall data and appliance information.



Press Back button (7) to return to previous menu.

SET WASH MODE

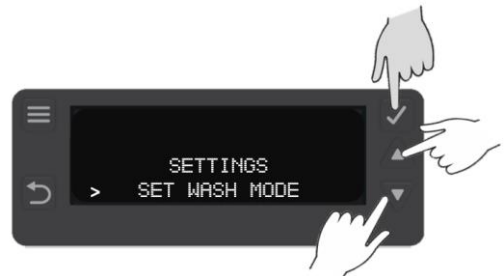

Press Select Button (2) to enter the SET WASH MODE settings
Press UP Button (4) & DOWN Button (5) to select wash mode either Glasswasher or Dishwasher. Confirm your selection by pressing Select Button (2).

Please Note: Your warewasher automatically adjust the temperature required for different wash mode.

	Dishwasher	Glasswasher
Wash	60°C / 140°F	60°C / 140°F
Rinse	82°C / 180°F	70°C / 158°F

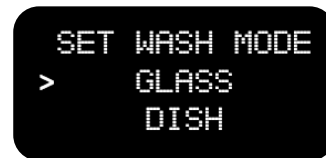

Press Back button (7) to return to previous menu.

CHANGE UNIT



Press Select Button (2) to enter the CHANGE UNITS settings
Press UP Button (4) & DOWN Button (5) to select units in

either Centigrade C or Fahrenheit F . Confirm your selection by pressing Select Button (2).



Press Back button (7) to return to previous menu.

SERVICE



These settings can only be access by qualified electrician or technician. Failure to do can result in warewasher malfunction.

Contact Classeq Technical for more information.

"90001723 Engineers' Manuals" covers the access of these settings.

This manual is available for engineers to download via Classeq's Website or APP.

9. Troubleshooting

If you believe the warewasher is not behaving as expected or has gone into error mode (Cycle indicator illuminated red), reset the warewasher by switching OFF & ON the mains supply to the warewasher, then follow the troubleshooting tips before requesting a service callout. The service support number can be found in the Useful Contact Details section (►11).

Note: In the event of a service call being made under Warranty and it is found that the fault(s) are due to non-observance of instructions in this manual, the call will be charged at current rates.

Problem	Possible Cause	Solution / Check
Warewasher does not fill.	The warewasher is still heating the water in the Rinse Boiler, indicated by the Fill/Heat indicator flashing amber.	Wait for heating stage to complete.
Warewasher has not filled, and Fill/Heat indicator has been flashing amber for more than 30 minutes. E12 E13	There is a problem with the water supply.	Ensure the water supply hose is connected to the warewasher and has not been trapped or kinked. Ensure the water supply is turned on. Check that the site water supply has not been turned off.
	The warewasher is not turned on.	Press the On/Off button.
	The door is not closed properly.	Close the door.

Warewasher will not turn on.	There is a problem with the power supply.	Ensure the warewasher is connected to the mains power supply. Check the power supply outlet is turned on. On 13A warewasher s check and replace the fuse in the plug, ensuring that the correct rating is used. On all ratings of warewasher check and reset the circuit breaker in the site fuse board. If the fuse or breaker keeps tripping, request a service callout.
Warewasher fills slowly. E13	There is a problem with the water supply.	Ensure the water supply is turned fully on. Ensure the water supply hose has not been trapped or kinked. Check that the site water supply has not been turned off. Check that the site water pressure is adequate (►4.5.1).
Warewasher is over filling (too much water in the Wash Tank - visible with the Door open, or water spills out when the Door is opened). E16	There is a problem with the drains system.	Attempt to drain the warewasher (►6.9). If warewasher does not drain, stop the warewasher and check the site drains system.
	There is a problem with the ware washer's control system.	Request a service callout.
Warewasher is over filling (pumped drain warewasher s only).	Drain Pump failure.	Attempt to drain the warewasher (►6.9). If warewasher does not drain, stop the warewasher and request a service callout.

Warewasher does not heat up.	Warewasher not turned on.	Check that the indicators and display on the Control Panel are illuminated. Press the On/Off button.	cycle until all cycle start criteria have been met. When the criteria have been met the heat indicator will illuminate green and the cycle should start. If this is not the case, please check the below items before requesting a service callout.)	Warewasher still going through fill / heat cycle.	Check that Fill/Heat indicator is flashing amber. Allow enough time for the warewasher to fill and heat (►6.3). Please refer to the latest version of the Engineers Manual on the Classeq website for full information regarding temperatures and interlock settings.
	Warewasher not able to fill.	Ensure the water supply is turned fully on. Ensure the water supply hose has not been trapped or kinked. Check that the site water supply has not been turned off. Check that the site water pressure is adequate (►4.5.1).			
	Warewasher still going through fill / heat cycle.	Check that Fill/Heat indicator is flashing amber. Allow enough time for the warewasher to fill and heat (►6.3).			
Excessive foam in Wash Tank.	Wrong type of wash and/or rinse aid chemicals.	Check that the wash and/or rinse aid chemicals are commercial ware washer grade. Always use the correct grade of chemicals.	Cycle runs for a long time.	Wash Tank not full.	Ensure the water supply is turned fully on. Ensure the water supply hose has not been trapped or kinked. Check that the site water supply has not been turned off. Check that the site water pressure is adequate (►4.5.1).
	Wash and/or rinse aid chemical injection rate too high.	Check / adjust the injection rates of the wash and rinse aid chemicals.			
	Wash Tank not fully heated.	Check Wash Tank temperature on Control Panel display.			
	Wrong type of Prewash	Do not prewash with soap-based detergent.			
Cycle does not start. (Your warewasher has a heat interlock that will delay the start of the wash	Warewasher not turned on.	Check that the indicators and display on the Control Panel are illuminated. Press the On/Off button.	Rinse water not hot enough.	Your warewasher has a heat interlock to ensure that the rinse is in accordance with UK environmental health requirements. This will extend the wash cycle if the Rinse Boiler has not achieved the required temperature If rinse water is not hot enough the Fill/Heat indicator will be flashing amber. Check Rinse Tank temperature on Control Panel display. Please refer to the latest version of the Engineers Manual on the Classeq website for full information regarding temperatures and interlock settings.	

Warewasher runs through a full cycle but does not rinse.		If your warewasher runs through a full cycle, but does not rinse, you will need to request a service callout to identify the root cause of the problem.	Warewasher not properly cleaned.	Ensure that the warewasher is regularly cleaned (►7.2). Check for presence of beige or black film deposits around the door and door hinges of the warewasher indicating a build-up of growing yeast cells. Check glasses and renovate if required.		
Warewasher overflowing. E16	Wrong Drain Plug fitted.	Check that the Drain Plug is the right one for the warewasher (►4.6).	Warewasher does not drain.	Check that the Drain Plug is the right one for the warewasher (►4.6).		
	Primary / Secondary Filters blocked.	Check the Primary / Secondary Filters - if blocked remove and clean thoroughly.			Wrong Drain Plug fitted.	Check the Primary / Secondary Filters - if blocked remove and clean thoroughly.
	There is a problem with the drains system.	Check that the warewasher waste hose is not kinked or blocked. Check that the site waste is not blocked.			Primary / Secondary Filters blocked.	
		If the warewasher continues to overflow isolate the warewasher and request a service callout.	There is a problem with the drains system.	Check that the warewasher waste hose is not kinked or blocked. Check that the site waste is not blocked. Correct drain procedure is being used for the warewasher type (►6.9).		
Poor wash results.	Warewasher not being supplied with soft water.	Check the operation of the Water Softener (external or internal) if fitted. If external, regenerate the Water Softener. If internal, check / refill the Salt Reservoir.	Ball in anti-syphon device dirty / blocked (pumped drain warewashers only).	Remove the anti-syphon device cover inside the warewasher, gently clean the ball by inserting and agitating a small bottle brush, flush using a trigger spray bottle with a jet nozzle.		
	There is a problem with the wash and rinse aid chemicals system.	Check the level of chemicals within the detergent and rinse aid bottles. Ensure the bottle weights and tubes are correctly positioned. Check the chemical dosing rates are correctly set (►).			Warewasher will not turn off when the On/Off button is pressed.	There is a problem with the warewasher's control / electrical system. Isolate the electrical supply to the warewasher, turn off the water supply, and request a service callout.

10. Decommissioning

If for any reason you need to remove or decommission your warewasher, do so in accordance with local and national regulations.

Classeq recommends the following procedures are followed.

10.1 Flush Out Chemical Dosing Systems

Prior to removing any chemicals refer to all safety statements on the chemical bottles for dealing with any spillage.



Warning!

Wear the correct Personal Protective Equipment, e.g., gloves and goggles, when handling chemicals and observe all safety notes and dosing recommendations printed on the packaging.

1. Remove the chemical tubes from the chemical bottles.
2. Place the ends of the tubes into a container of water.
3. Use the commissioning menu to prime the Rinse Aid and Detergent Pumps to draw water all the way into the warewasher.
4. Fill and drain the warewasher to remove any chemical residue.
5. Ensure the bottles are then capped to prevent any spillage.

10.2 Drain the Warewasher

6. Ensure the warewasher is fully drained (►6.9).
7. Remove the Waste Hose from the drain standpipe; ensure any spilt liquid is dried prior to advancing to the next stage.

10.3 Disconnect the Warewasher

8. Turn off the mains electrical supply at the socket / isolator / junction box.

When disconnecting the warewasher from the mains electrical supply:

- Warewashers with an electrical plug, always pull the plug. Never pull the cord itself.

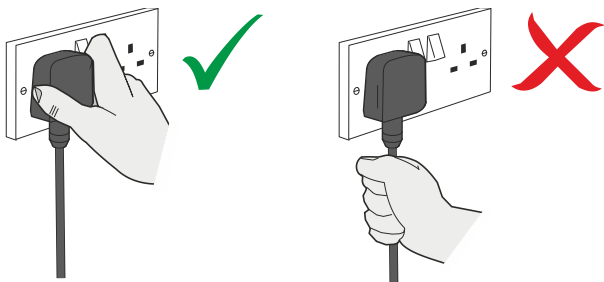

- Warewashers that are hardwired (*i.e. no plug*), must be disconnected in accordance with local and national regulations. **Classeq** recommends this is performed by a qualified electrician.

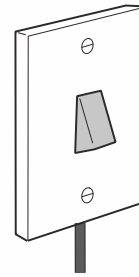

9. Once the electrical supply has been disconnected, disconnect the equipotential wire from the stud at the rear of the warewasher.
10. Turn off the water supply to the warewasher and disconnect the Water Supply Hose from the mains water supply, ensuring any spillage is cleared up.

10.4 Drain the Rinse Tank / Boiler

11. Remove the lower Front Panel from the warewasher using a POSI HEAD SCREW DRIVER.
12. Locate the Boiler Drainage Hose. Ensure the Hose protrudes from the front of the warewasher.
13. Position a container large enough to hold eight litres of water so that the Hose will drain into it.

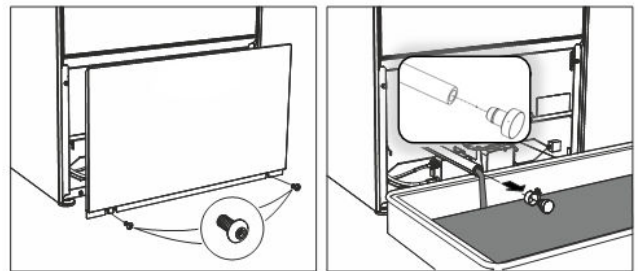

Warning!

If the warewasher is being drained immediately after use, the water draining from the Boiler Drainage Hose may be as hot as **95°C**.

14. Loosen the Jubilee Clip and remove the Drain Plug, ensuring the water flows into the container. Once fully drained replace the Drain Plug and retighten the Jubilee Clip.
15. Replace the Front Panel, and ensure all cables and hoses are secured to the warewasher to prevent tripping hazards. The warewasher is now ready to be removed.



RECYCLING: If you are recycling or disposing of your warewasher, you must ensure this is done in accordance with local and national regulations.

11. Warewasher Specifications

11.1 Dimensions

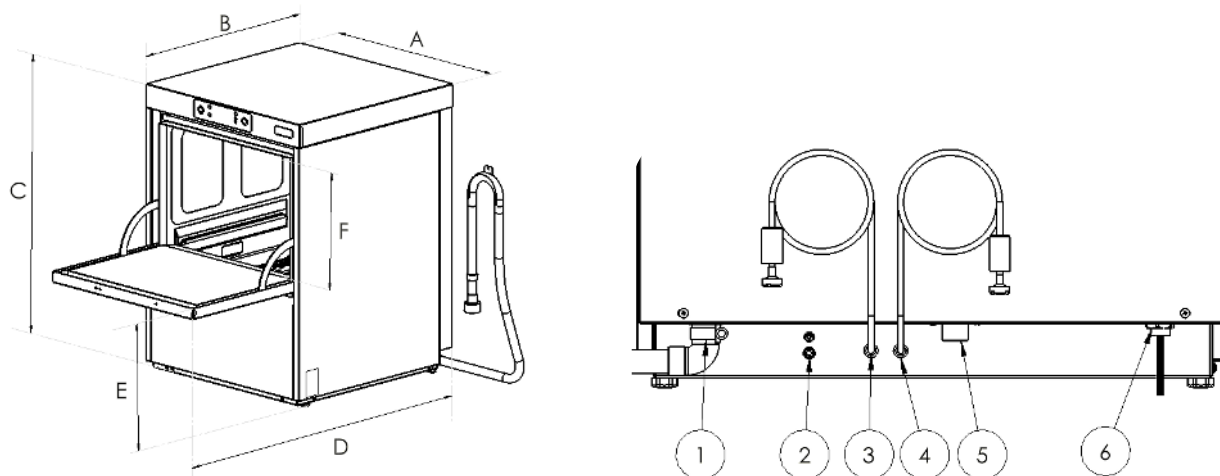

Model No.	C400	C500		
A. Width (mm)	460	600	1.	Drain Wastewater Outlet Port
B. Depth - door closed (mm)	570	600	2.	Equipotential Bonding Stud
C. Height (mm) min/max	720/750	820/850	3.	Detergent Tube (Clear)
D. Depth - door open (mm)	910	990	4.	Rinse Aid Tube (Blue)
E. Height to open door (mm)	310	364	5.	Water Inlet Port
F. Entry Clear Height (mm)	312	352	6.	Mains Electrical Cable

11.2 Technical Data

Model No.	C400	C500	Model No.	C400	C500
Water supply connection	G $\frac{3}{4}$ " ($\frac{3}{4}$ "BSP)	G $\frac{3}{4}$ " (3/4"BSP)	Voltage - option 2 (V)	220-240 /1N~/50Hz	220-240 /1N~/50Hz
Water pressure - min (bar)	2.0	2.0	Power consumption - option 2 (kW)	2.58kW	2.58kW
Water flow rate - min (L/min)	4	4	Wash Tank element rating (kW)	2.00	2.00
Water temperature - min/max (°C)	4/55	4/55	Rinse Tank element rating (kW)	6.00	6.00
Drain Pump Flow rate (L/min)	18	20	Wash Tank capacity (litres)	9.50	15.00
Drain height - pumped (mm)	540	600	Rinse Tank capacity (litres)	6.5	6.5
Drain size (mm)	Ø40	Ø40	Rinse water consumption @3bar (L/cycle)	3.00	3.00
Current - standard (A)	30 (1ph)	30 (1ph)	Wash Tank temperature (°C)	60	60
Voltage - standard (V)	220-240 /1N~/50Hz	220-240 /1N~/50Hz	Dish - Rinse Tank temperature (°C)	82	82

Model No.	C400	C500	Model No.	C400	C500
Power consumption - standard (kW)	6.58kW	6.58kW	Glass - Rinse Tank temperature (°C)	70	70
Current - option 1 (A)	13 (3 ph)	13 (3 ph)	Noise level (dB)	<70	<70
Voltage - option 1 (V)	380-415 /3N~/50Hz	380-415 /3N~/ 50Hz	Weight - empty (kg)	40	52
Power consumption - option 1 (kW)	6.58kW	6.58kW	Weight - fully loaded (kg)	46	60
Current - option 2 (A)	13 (1 ph)	13 (1 ph)	Weight - packed (kg)	52	68

11.3 National Approvals Requirements

11.3.1 Watermark

- This appliance complies with WMTS-101 (Cert No. WM-021982)
- The maximum water pressure is 600kPa

11.3.2 Installation

- Installation shall be in accordance with AS/NZS3500.1
- Installation shall include the supplied backflow prevention device (dual check valve).

12. Ordering Accessories and Supplies

To view and order accessories and supplies for your product please go to the **Classeq** website.

www.classeq.co.uk

13. Parts and Labour warranty

Classeq Ltd.

Parts and Labour Warranty Terms

The user is entitled to free replacement and fitting of any part found to be faulty in material or workmanship, including any parts rendered inoperative by the effect of a faulty component, for a period of one year, or as specified by the vendor at the time of purchase.

Exceptions

All faults or conditions caused by Operator misuse, including (but not exclusively):

- Incorrect Installation.
- No fault found.
- Problems with electricity supply or plumbing e.g., water and waste.
- Failure to follow instructions in the User Handbook.
- Use of incompatible chemicals or chemical set at incorrect concentration.
- Drain pump or drain system blocked or damaged by foreign bodies.
- Wash pumps damaged due to foreign bodies entering the wash system.
- Use of un-softened (hard) water. The use of a faulty water softener or the failure to properly regenerate a water softener.
- Use of excessive force on the warewasher, e.g., switches etc.
- The cost of replacing any item found to be lost or missing.
- Use of non-compatible cleaning materials.
- Incorrect assembly after cleaning.
- Damage to warewasher caused by any 3rd party.

Useful Contact Details

Classeq Ltd

Classeq House
Beacon Business Park, Beacon Way, Stafford,
ST18 0DG United Kingdom

<https://www.classeq.co.uk/>

Sales and Switchboard

tel: +44 (0)844 225 9249

email: sales@classeq.co.uk

Service

tel: +44 (0)844 225 9245

email: service@classeq.co.uk

Technical

tel: +44 (0)844 225 0700

email: technical@classeq.co.uk

Country	Place	Service Email, Phone	Sales Email, Phone	Orders Email, Phone
Belgium	Vilvoorde	service@eliona.be +32 2 255 18 50	classeq@eliona.be +3222551810	info@eliona.be +3222551810
Sweden	Uppsala	info@winterhalter.se	info@winterhalter.se	info@winterhalter.se
France	Chaponost	infos@classeq.fr	infos@classeq.fr	infos@classeq.fr
Italy	Cardano al Campo	info@winterhalter.it +39 0331 734147	info@winterhalter.it +39 0331 734147	info@winterhalter.it +39 0331 734147
Netherlands	Oosterhout	info@classeq.nl +3185 20 300 31	info@classeq.nl +3185 20 300 31	info@classeq.nl +3185 20 300 31
Austria	Thalgau	kundendienst@winterhalter.at +43664 3522200	info@winterhalter.at +436235 50222-0	info@winterhalter.at +436235 50222-0
Switzerland	Rüthi	info@classeq.ch +41 71 767 80 00	info@classeq.ch +41 71 767 80 00	info@classeq.ch +41 71 767 80 00
Greece	Xanthi	informacije@winterhalter.si	informacije@winterhalter.si	informacije@winterhalter.si
Germany	Meckenbeuren	info@classeq.de +497542 / 4025454	info@classeq.de +497542 / 4025454	info@classeq.de +497542 / 4025454
Poland	Warszawa	serwis@classeq.pl +48 515 999 019	biuro@classeq.pl +48 22 813 03 25	zamowienia@classeq.pl +48 22 813 03 25
Russia	Moscow	info@classeq.ru +7 985 195 0390	info@classeq.ru +7 917 502 1717	info@classeq.ru
Czech Republic:	Ricany / CZ	info@classeq.cz	info@classeq.cz	info@classeq.cz
Slovakia	Zilina / SK	info@classeq.sk	info@classeq.sk	info@classeq.sk
Hungary	Budapest / HU	info@classeq.hu	info@classeq.hu	info@classeq.hu
Spain	Malaga	info@classeq.es + 34 952 247 600	info@classeq.es + 34 952 247 600	info@classeq.es + 34 952 247 600
Brazil	São Paulo	info@classeq.com.br +55 11 42212121	info@classeq.com.br +55 11 42212121	info@classeq.com.br +55 11 42212121
Chile		info@classeq.cl +56 2 321103107	info@classeq.cl +56 2 321103107	info@classeq.cl +56 2 321103107
Colombia	Bogota	info@classeq.co +57 1 3819272	info@classeq.co +57 1 3819272	info@classeq.co +57 1 3819272
Mexico	Puebla PUE	info@classeq.com.mx +52 222 582 5678	info@classeq.com.mx +52 222 582 5678	info@classeq.com.mx +52 222 582 5678
Turkey	Istanbul	servis@winterhaltertr.com +90 212 447 2999	info@winterhalter.com.tr +90 212 447 2999	halil.akturk@winterhalter.com.tr +90 212 447 2999
Serbia	Beograd	info@classeq.rs +38111 / 2085950	info@classeq.rs +38111 / 2085950	info@classeq.rs +38111 / 2085950
Montenegro	Budva	info@classeq.rs +38111 / 2085950	info@classeq.rs +38111 / 2085950	info@classeq.rs +38111 / 2085950
Slovenia	Grosuplje	informacije@winterhalter.si	informacije@winterhalter.si	informacije@winterhalter.si
Australia	Sydney	sales@winterhalter.com.au +61 (0) 9645 3221	sales@winterhalter.com.au +61 (0) 9645 3221	sales@winterhalter.com.au +61 (0) 9645 3221
South Africa	Johannesburg	sales@winterhalter.co.za +27 (0) 11 888 7932	sales@winterhalter.co.za +27 (0) 11 888 7932	sales@winterhalter.co.za +27 (0) 11 888 7932
India	Haryana	info@classeq.in +91 (0) 124 487 9750	info@classeq.in +91 (0) 124 487 9750	info@classeq.in +91 (0) 124 487 9750
Middle East	Al Quasis	info@winterhalter.ae +971 (0) 4296 5727	info@winterhalter.ae +971 (0) 4296 5727	info@winterhalter.ae +971 (0) 4296 5727

Document number: 90001697

Revision: A

Date: 01/02/2024

Language: English